

OUTSIDE HOME

weinor patio roofs and Glasoasen®







PATIO ROOF or **GLASOASE®**
Just the way you like it





TERRAZZA patio roof Enjoy life al fresco

Enjoy your patio until well into autumn – weinor's Terrazza patio roof will keep you well sheltered from the wind and other elements. And your patio furniture can remain outside without being damaged. The appeal of weinor's patio roof is its elegant construction, attractively shaped design and high durability. With numerous versions available, it is also very suited to many different types of houses and requirements.



Frame colour WT 029/80081 | Pattern 3-515

The right patio roof for every application

weinor patio roofs stand out not only for their very elegant design and seamless look. With so many versions to choose from, they also adapt effortlessly to complex building situations. A completely modular construction allows you to start with the basic roof and add glazing elements, shading products or accessories at any time in the future!

TERRAZZA – Highlights and versions



Three roof types for all styles

The high-quality weinor patio roof provides weather protection all year round. The model is available with or without roof overhang – with integrated rain

gutter in both cases. The broad range of roof models offers just the right complement for any type of building.



Elegant design – as if from one casting

The weinor Terrazza patio roof captivates through its harmonious design. The elegant yet rigid construction is thought out down to the finest detail:

- almost all fixings are concealed for a clean appearance
- corrosion-resistant with extruded aluminium profiles and stainless steel screws



Rigid roof covering – resilient and shatter-proof

The weinor Terrazza is designed for use with high quality for high-quality laminated safety glass (LSG):

- the resilient construction is based on structural calculations by certified engineering consultancies
- roofing from 10 or 12 mm LSG
- if required, the roof can carry a snow load up to 550 kg/m²



Invisibly integrated drainage (Terrazza and Terrazza Plus)

Rainwater is efficiently drained away by the discretely integrated gutters and drainage outlets inside the post. The drainage outlet can also be positioned at the end of the gutter profile. The optional foliage screen prevents the ingress of leaves

and the like into the rain gutter. There is a choice of two post styles – 115 post (square) and 90 post (round). So the best match can be made to either the existing surroundings or simply a preferred style.

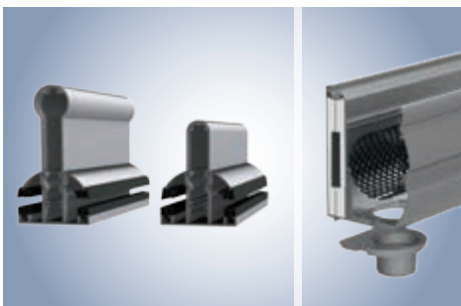

Rigid aluminium construction

weinor patio roofs stand out for their exceptional stability and durability. These durable constructions are based on static calculations run by a certified engineering company.

- sturdy roof supports in a variety of configurations
- snow-bearing load up to 550 kg

- extra-thick walls in a slim structure
- steel inserts optionally available, also as guttering reinforcements if required
- corrosion-proof thanks to aluminium profiles and stainless steel screws
- roof depths up to 6 m



TERRAZZA – Roof types and accessories

Three roof models – equipped exactly the way you need them

To ensure that the roof is a perfect match for the facade it is fitting to, there are several different options and roof types to choose from (see p. 11).



Patio roof without overhang, with integrated guttering

The basic model comes in a classic lean to design: if you don't need an additional roof overhang, you will find the Terrazza Originale a good solution.



Patio roof with roof overhang and pre-fitted guttering

The protruding roof on the slender Terrazza Extra version blocks out rain falling at an angle.



Patio roof with roof overhang and integrated guttering

Or opt for a Terrazza Plus with roof overhang and integrated downspout – to make sure the rain drains off as it should.



LED/Design light bar

Our light bar extends the amount of time you can use your patio roof until well into the evening. The light bars can be wall-mounted or fitted to a roof support depending on your preference.

- warm, atmospheric light thanks to special glass lenses
- highly energy-efficient
- operating life of 30,000 hours
- radio-controlled dimmer using BiConnect
- light bar housing in same colour as patio roof



Frame colour RAL 9016

Contact your weinor retailer/partner for advice!

weinor patio roofs and Glasoasen® blend in to the shape and appearance of any building facade – even on protruding walls and corner solutions. Your weinor retailers and partners will be happy to explain to you which style of roof is suitable for your needs. Most roof models and types can be very easily combined with weinor glazed elements.

TERRAZZA – Styles of roof

Roof models (see p. 7)



Terrazza Originale model

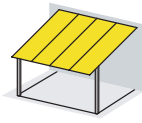

Terrazza Extra model with roof overhang and pre-fitted guttering

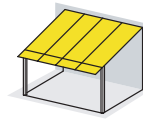

Terrazza Plus model with roof overhang and integrated guttering

Roof types for Terrazza patio roof and Glasoase® (see p. 9 + 13)

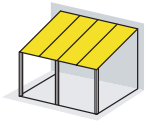

Pent roof – Type A



Sloping pent roof – Type B



Trapezium-shaped roof sloping to eaves – Type C

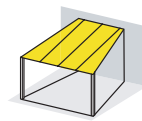

Trapezium-shaped roof sloping to ridge – Type C



Pent roof with wall offset

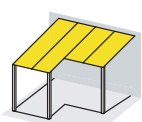

Pent roof with roof guttering offset

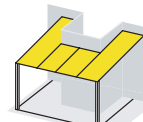

Pent roof with balcony cutout

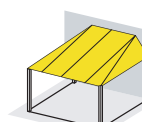

Hipped pent roof



Pent roof, hipped and sloping forwards

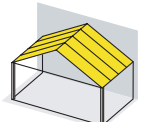

Gable roof – Type L

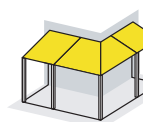

Circumferential pent roof – Type N

Matching side glazing – tailored to your needs and wishes

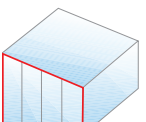

Maximum transparency: SUPER LITE side element

Adding fixed glazing below the Terrazza side roof support opens up the possibility to include fully-transparent front panels – with not a single vertical or horizontal strut in sight.

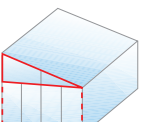

Complements the folding partition and sliding wall: LITE side element

Lightweight fixed glazing at the top of the trapezium, with a weinor easy-glide sliding wall below, or a multi-function folding partition – if you go this way, you'll be choosing a very popular combination!

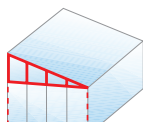

As stable as they come: CLASSIC side element

Or go for sturdy fixed glazing at the top of the trapezium, with a multi-function sliding wall below – or even framed fixed glazing to hold off strong side winds if you prefer.





Frame colour WT 029/90147

weinor Glasoase® Light-flooded elegance

Bring your garden into your house – with the elegant weinor Glasoase® that offers you smooth transitions to the outside. This glass oasis is a combination of a Terrazza patio roof comprising all-glass elements that can be closed to form an uninsulated conservatory. The many flexible and fixed-glazed side elements allow for any number of possible combinations. To see our roof shapes, please go to p. 11.



reddot design award
winner 2009
weinor Glasoase®



Frame colour WT 029/80077

The effortless all-glass system

It doesn't get any easier than this. Thanks to its premium quality components and fittings, weinor's all glass sliding door is a breeze to operate and can also be locked if needed.

ALL GLASS EASY-GLIDE SLIDING DOOR w17-c

Highlights and options



Easy to open – convenient and user-friendly

The easy-glide sliding wall is outstandingly easy to operate.

- very user-friendly all-glass elements
- sliding the panels is a breeze
- exceptionally smooth operation
- foot-operated lock on the inside – no need to bend over



Actuator function – all the panels can glide at the same time

The intelligent actuator function makes for very fast operation of the all-glass elements.

- slide multiple panels in one go
- close entire fronts with a flick of the wrist



Retrofittable – for virtually every patio roof

Being a floor-mounted structure, weinor's easy-glide sliding door fits under virtually every patio roof as well as numerous roof structures.

- weinor Terrazza can be added to create a Glasoase®
- no additional costs for structural safety adjustments
- matching profiles from weinor for easy retrofitting



Frame colour WT 029/90147

All-glass elements for balconies and loggias

weinor has many suitable solutions for anyone wishing to use their balcony whatever the weather. The utility slide-and-turn partition is the ideal solution for balconies and loggias.

USER-FRIENDLY SLIDE-AND-TURN PARTITION w26-c

Highlights and applications



Simply slide open and swing neatly out of the way

The multi-utility slide-and-turn partition runs on only one narrow guide rail and therefore is suitable for the majority of existing balcony balustrades.

The glass panes are simply pushed to the side or round the corner and turned into the parking position to save space.

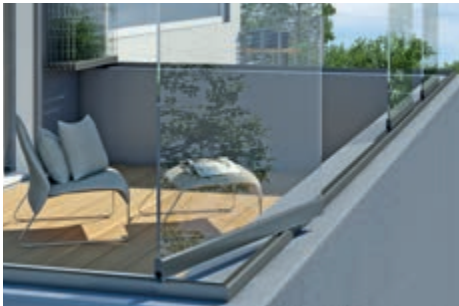

Slide them round the corner – and open up the entire front

The glass panes of the utility slide-and-turn partition can be completely guided round the

corners. Opening direction to the right, to the left or in both directions, as you wish.



Retrofittable – ideal for existing balconies and loggias

The utility slide-and-turn partition is a so-called “hanging system” and therefore does not put any stress on the balcony

balustrade. Especially suitable for retrofitting existing balconies and loggias.



Ideal balcony glazing – for a fantastic open air feeling

With the utility slide-and-turn partition, the panes are guided to the wall and turned into the parking position. The glass front is opened completely, for the perfect open-air feeling.

What’s more, the outside panes can easily be reached in this position, making them easy to clean.







WGM 1030/2030, SOTTEZZA II, VERTITEX Three perfect sun shades

With the right form of sun protection for your patio roof, Glasoase® or conservatory, the fabric will shelter you from the heat, glare and prying eyes – and also make you feel even more at home. For well-ventilated patio roofs and Glasoasen®, often the only anti-glare protection that you need is an undermounted conservatory awning. A conservatory can quickly become very warm when the sun shines in. This is where a roof-mounted conservatory awning can help provide a pleasant indoor environment. Vertical protection from the sun and prying eyes comes in the shape of our red dot award-winning VertiTEx vertical awning.



Frame colour RAL 9016 1 Pattern 3-512

Roof-mounted awnings that stand the test of time

weinor's roof-mounted WGM 1030 and 2030 conservatory awnings guard against overheating and therefore help create a pleasant climate. As they are robustly constructed, these awnings can remain open up to wind force 6 despite their large fabric surface. Can be retrofitted to virtually any roof type.

WGM 1030/2030 – Highlights and features

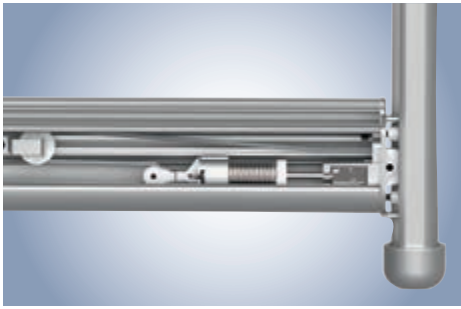

Clever tensioning system – taut fabric and wind stability

The ingeniously designed block and tackle incorporated into the tensioning system, plus a fast-reacting tension spring, ensure the fabric is taut at all times.

- tear-resistant and high-tensile Tex-Seil rope as used in ocean sailing
- patented rope winding – controlled and near-noiseless

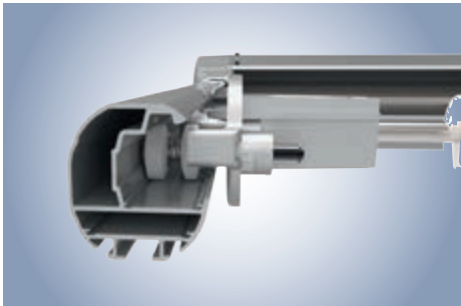

weinor carriage system – precise and low-noise

The appeal of weinor's tried-and-tested carriage, with its precision rollers, is that it runs very quietly.

- smooth, low-noise opening and closing

- precise running and exact winding of the textile rope in the carriage
- loose-fitting bearing on carriage prevents it from jamming in side winds

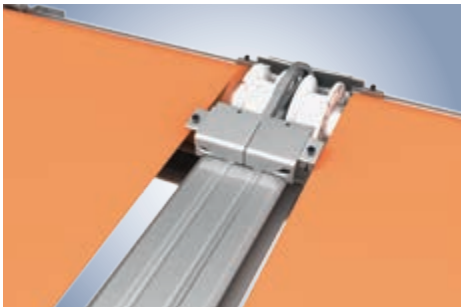

Coupled multi-panel systems – for large dimensions

Large areas can be shaded using a multi-section unit. The coupling system makes sure fabrics open to the exact same position every time, even on large units.

- simultaneous opening and closing for harmonious appearance
- WGM 2030 opens to any desired length
- two-section units can be operated with one or two motors



Fabrics – attractive, brilliant long-lasting colours

A high-quality fabric is the basis of a beautiful awning. The 'colours by weinor®' collection provide a wide range.

- solution dyed to stay colour-fast

- lastingly beautiful thanks to dirt- and water-repellent nanocoating
- optional: wide range of collections by other manufacturers



Undermounted awnings with a homelike feel

The undermounted Sottezza II conservatory awning is an attractive anti-glare screen that is always a good choice below a Glasoase® or patio roof because it provides for ample air circulation. The customisable sizes also make it a good fit for any other rectangular patio roof.

SOTTEZZA II/LED – Highlights and versions



Under glass sun protection for cosy living

The lean form and beautiful fabric of the Sottezza II guarantees a cosy feeling under your patio roof. A huge range of fabric patterns and colours makes the designing a pleasure.

- additional range of climate-control fabrics Soltis® and Perluca

- optically matching for any patio roof
- suitable for retrofitting almost everywhere
- coupled systems also shade large areas



2 versions – taut fabric at all times

Sottezza II is available in 2 designs: Sottezza II OptiStretch enclosed all-round with fabric and the cheaper Sottezza II Stretch with open sides.

Sottezza II OptiStretch: completely enclosed on all sides, no light apertures on the side or overhanging edges of fabric

Sottezza II Stretch: even fabric positioning, small fabric gap on the sides

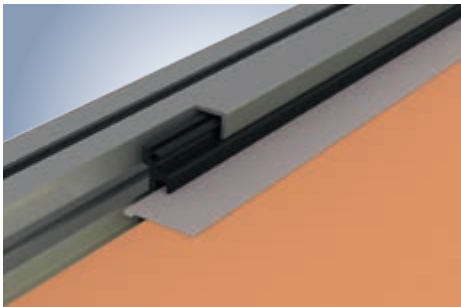

Sottezza II OptiStretch – the best all-around fabric tension

Sottezza II OptiStretch is clamped firmly on all four sides. This reduces the risk of fabric sag enormously. The problem of sideways hanging edges is also solved.

- the fabric is positioned securely in the side channel – just like a zip
- no sideways light apertures occur



Long evenings with integrated LED lighting

Enjoy long evenings on your patio – the Sottezza II LED provides atmospheric lighting. The cassette with integrated LED lighting blends discreetly into the architecture of the patio roof.

- operating life of 30,000 hours
- highly energy-efficient
- with weinor radio control, continuous dimming



Convincing technology for an evenly taut fabric

The tried and tested rope clamping system also ensures even fabric positioning with the Sottezza II.

- tear-resistant and high-tensile rope
- extremely quiet and easy running
- tried-and-tested clamping system over many years



Frame colour RAL 7016 | Pattern 86-2044

Maximum fabric widths in the smallest cassette

With an exterior vertical shade from our red dot award-winning VertiTex line, you have an anti-glare screen, wind protection and privacy screen all rolled into one. The patented OptiFlow-System® allows us to use a very small and slim cassette on the VertiTex – yet it is still big enough to house large awning fabrics.



reddot design award
winner 2008
weinor VertiTex

VERTITEX – Highlights and versions



VertiTex WeiTop – ideal for patio roofs and Glasoase®

The shape of the VertiTex housing makes it an ideal match for the guttering on a Terrazza patio roof and a Glasoase®.

This allows it to blend in perfectly into the overall design.

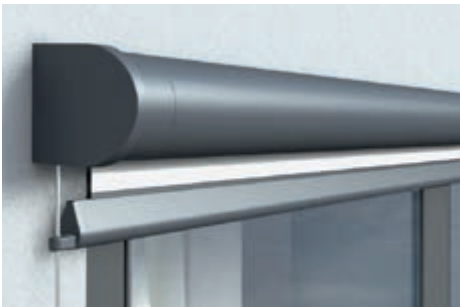

VertiTex versions – also for windows and balconies

Thanks to their various installation possibilities, the VertiTex rope or guide versions are also suited to shading windows or balconies.

The dainty housing forms a harmonious whole with the window.



Fabrics – attractive, brilliant long-lasting colours

A high-quality fabric is the basis of a beautiful awning. The weinor collection provide a wide range.

- solution dyed to stay colour-fast
- lastingly beautiful thanks to dirt- and water-repellent nanocoating



BiConnect
Simply intuitive.



Frame colour WT 029/70786 | Pattern 3-716



Alternatively, you can operate every element of your awning on your patio or terrace using RTS or io-homecontrol® from **somfy**.

Great comfort thanks to smart solutions

Would you like to be able to control your patio lighting, heating system or awning at the press of a button from your sun lounger? And for the awning to retract all on its own if it's windy and rainy even if you're not at home? Then BiConnect from weinor is just the right solution for you. An easy to operate hand transmitter with or without display even sends the interference-free radio signal through metal facades and thick insulating layers. And it's even possible to control them using a tablet or phone with the BiEasy app.

ACCESSORIES and CONTROL – Comfort and security

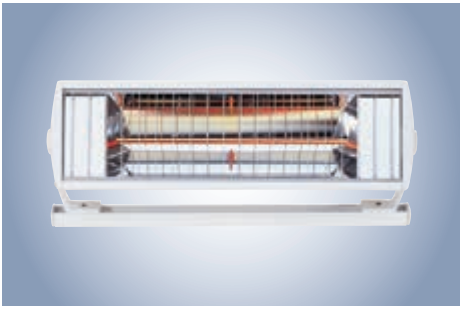

Tempura heating system – cosy warmth on cooler days

Pleasant, instant heat without any pre-heating: the energy-efficient Tempura infrared heater delivers a heat output of over 1,500 watts. Very easy to operate and control using the BiConnect radio controls.



LED/Design/3Spot light bar – patio enjoyment into the evening hours

Light bars can significantly extend the time you can use your patio.

- atmospheric light thanks to special glass lenses

- highly energy-efficient
- operating life of 30,000 hours
- radio-controlled dimmer using BiConnect



Weather sensors – automatically react to wind and weather

Sensor technology automatically opens your awning when the sun comes out and can optionally retract it in the wind and rain:

- solar sensor
- sun and wind sensor (solar-powered version also available)
- sun, wind and rain sensor



Roof vents for a breath of fresh air

The WeiTop DL permanent roof vent provides a healthy climate and reliable ventilation.

- ingenious design using overlapping roof covers

- spent air is constantly LED outside
- optional insect screen
- optional winter screen for better thermal protection

47 standard RAL colours



Over 200 modern FRAME COLOURS

Colour manufacturers make every effort to guarantee colour stability. Despite this, as a result of the ban on the use of heavy metals in powder coatings, it therefore cannot be excluded that colours in general, and Fire Red (RAL 3000) in particular, may fade with time. Colours may differ significantly due to the printing process.

Maximum colour safety: weinor has over 200 different frame colours for you to choose from. You can choose from diverse colours which harmonise with the architecture.

Identical colours – for a perfect match

As weinor does all the powder coating in its own workshop, you can also rest assured that different weinor products come with the same top-class colour tonality and identical gloss level.

Choose from an abundance of high-quality colours:

- 47 standard RAL rack colours, silk gloss
- 9 scratchproof, resistant trend colours with an elegant textured look
- over 150 special RAL colours

RAL 8003
Clay brown

RAL 6012
Black green

RAL 1002
Sandy yellow

RAL 1015
Light ivory

RAL 1003
Signal yellow

9 trend colours

WT 029/10797
Approx.
RAL 9010

WT 029/80081
Iron glimmer
effect P7

WT 029/80077
Approx.
DB 703 metallic

WT 029/71289
Approx.
RAL 7016

WT 029/90146
Approx.
RAL 9006 metallic

WT 029/50704
Approx.
RAL 6009 metallic

WT 029/90147
Approx.
RAL 9007 metallic

WT 029/70786
Sparkling iron
effect

WT 029/60740
Chestnut 04
metallic



weinor – made in germany

Award-winning technology and designs



German Design Award

SPECIAL MENTION 2014



Focus Open 2014 Silver



Timelessly classic or puristically modern – with a weinor product, any outdoor area will become an extension of your living space. Numerous design awards bear testimony to our commitment to provide good designs:

- Red Dot Award 2016 “Best of the Best” for PergoTex II pergola awning
- Red Dot Award 2016 for Semina Life cassette-awning
- BTP Innovation Award (Label d’Or) 2016 for PergoTex II Pergola awning
- BTP Innovation Award 2016 for Sottezza II conservatory awning
- Product of the Year M&T 2016 for PergoTex II pergola awning
- iF product design award 2015 the weinor Livona open awning
- Product of the Year M&T 2015 for Sottezza II conservatory awning
- Focus Open 2014 Silver for Cassita II cassette-awning
- Red Dot Award 2014 for Zenara and Cassita II cassette-awnings and the weinor Livona open awning (honourable mention)
- iF product design award 2014 for Zenara, Opal Design II and Cassita II cassette-awnings
- German Design Award Special Mention 2014 for Zenara and Opal Design II cassette-awnings
- Good Design Award 2013 for Zenara cassette-awnings
- Focus Open 2012 for Zenara cassette-awning
- iF product design award 2011 for Plaza Pro pergola awning
- Red Dot Award 2009 for Terrazza Glasoase® cold roof conservatory
- Red Dot Award 2008 for VertiTex vertical sun protection



Premium quality
made in Germany



Embodying innovation

Innovation plays a central role at weinor: this applies to our products, which set the highest-possible standards with their ultramodern engineering, and every element of our corporate culture alike.

Tried and tested weinor quality

Defined work flows and manufacturing processes ensure that our products always meet the same high levels of quality. Numerous certifications also endorse this.

Ecology and responsibility

weinor is an eco-friendly company. To ensure compliance with high environmental standards, manufacturing processes and materials undergo regular testing by experts.

Important:

For textile sun protection: creases occur during manufacture and when folding the awning fabrics. This can lead to the areas of the fold appearing darker when seen against the light, particularly with light colours. Folds in the hem, seam and fabric lengths occur where there are multiple layers of the woven fabric and different rolling thicknesses on the fabric roller. The resulting fabric tension can cause waviness (e.g. honeycomb or fish bone patterns).

In principle, these effects occur to varying degrees in almost all awning fabrics. Creases and folds do not detract from the value and usability of an awning. Awnings and conservatory awnings are sun protection devices which should be retracted when it is raining or windy. Wet fabric creases more easily and as far as possible should only be retracted after drying out (please take care in strong winds and avoid pooling). Depending on the colour of the ordered frame, we

supply all small parts as well as gear handles and drives for systems with gear drives in black (similar to RAL 9005), white (similar to RAL 9016) or grey (similar to weinor 7319).

Note for patio roofs and Glasoase®:

Ask a qualified conservatory builder about the causes of condensation formation and any cracking sounds which may occasionally be heard and how to avoid them from the planning stage onwards.



Front and back cover: **Frame colour** WT 029/70786 | **Pattern** 3-716

We reserve the right to make technical changes. For technical reasons, the colours may appear slightly different when printed.

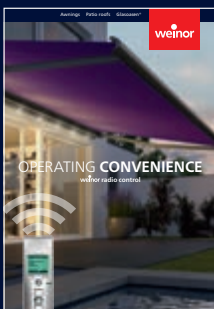
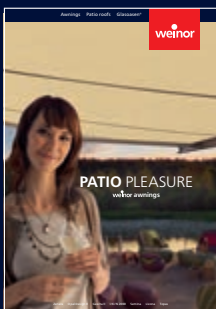
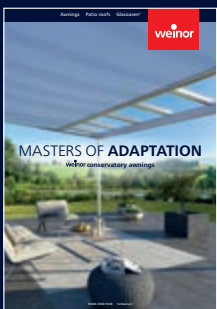

Experience the whole weinor.com world

Your specialist weinor partner will be pleased to advise you: